

CORCHI

ARTIGLIO 5000



TECHNOLOGY
PARTNER
product



Smontagomme automatico 28" con tecnologia CONTACTLESS "leva la leva"
LITE Smart Corghi System riduce lo stress dello pneumatico



Automatic 28" tyre changer with "leva la leva" CONTACTLESS technology
LITE Smart Corghi System reduces the stress on the tyre



ARTIGLIO 5000

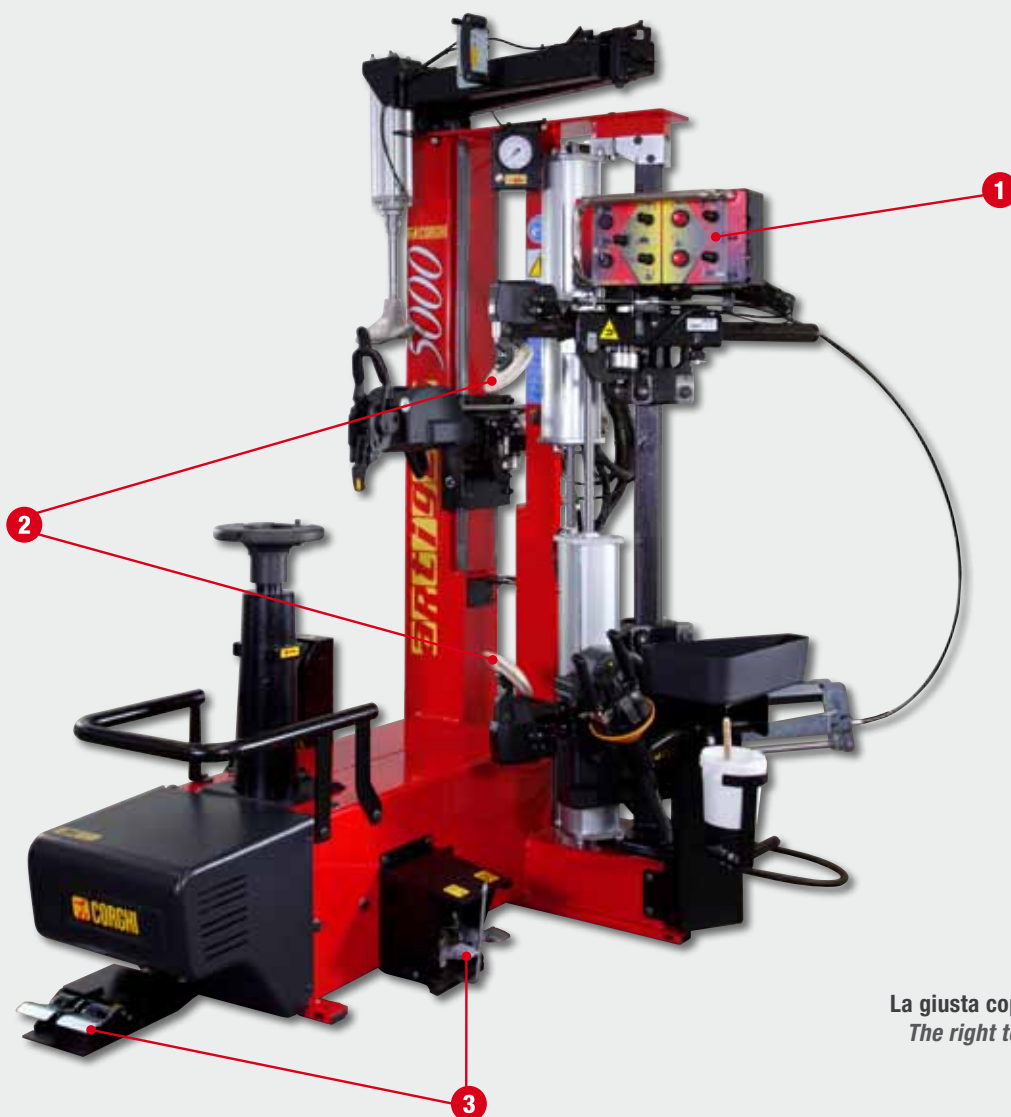

MOTOINVERTER:
La giusta coppia per ogni velocità
The right torque for every speed

Nuovo smontagomme automatico con tecnologia **“leva la leva” di 3ª generazione** per ruote vetture, SUV e veicoli commerciali **fino a 28”**. Il nuovo utensile di smontaggio con movimento **LITE SMART CORGHI SYSTEM** **riduce lo stress dello pneumatico e non tocca MAI il cerchio**. Numerose novità tecniche: dispositivo di stallonatura dinamica con **doppio disco stallonatore**, gruppo testata di nuova concezione **Patent Pending**, **bloccaggio ruota a platello** più performante, struttura rinforzata, grande cura dell’ergonomia e della fruibilità dei comandi. Tutto questo significa maggiore velocità operativa senza rischi per l’operatore e i cerchi, anche durante le fasi più impegnative, grande semplicità d’uso e universalità, per un’**attrezzatura sfruttabile al 100% in tutte le sue peculiarità**.

*New automatic tyre changer with **3rd generation “Leva la leva” (Without lever) technology** for vehicle, SUV and commercial vehicles wheels **up to 28”**. The new demounting tool with **LITE SMART CORGHI SYSTEM** movement **reduces the stress on the tyre and NEVER touches the rim**. Numerous technical innovations: dynamic bead breaking device with **double bead breaker disc**, newly designed head unit (**Patent Pending**), **wheel clamping with wheel support plate**, optimised performance, reinforced structure, excellent ergonomics and user-friendly commands. All of this means a faster operating speed without risks for the operator and the rims, even during the most critical phases, plus great ease of use and universality - **for equipment whose features can be used to the fullest**.*

1



CONSOLLE - CONSOLE

Intuitiva e completa - Consolle comandi multifunzione che racchiude tutti i comandi di lavoro. Ideale per la stallonatura dinamica e per la possibilità di eseguire il match mounting tra pneumatico e cerchio, grazie ai due dischi a doppio comando.

Intuitive and complete - The multifunctional control console contains all the operating controls. Ideal for dynamic bead breaking and for rim and tyre match mounting, thanks to the two dual control discs.

2 DOPPIO STALLONATORE A PENETRAZIONE CONTROLLATA - DYNAMIC BEAD BREAKING DEVICE WITH CONTROLLED PENETRATION

Dispositivo di stallonatura dinamica con doppio disco stallonatore speculare. Il posizionamento radiale dei dischi è facilitato da un automatismo in grado di evitare ogni posizionamento manuale dell'operatore.
Penetrazione controllata (Patented) Precisione, rapidità e ripetitività sono garantiti dal sistema di stallonatura brevettata e dalla perfetta specularità tra i due dischi.



Watch the Video

Dynamic bead breaking device with dual specular bead breaker disc. The radial positioning of the discs is made easier by an automatism that is able to prevent any manual positioning by the operator.

Controlled penetration (Patented) - Precision, rapidity and repeatability are guaranteed by the patented bead breaking system and by the perfectly synchronised and symmetrical motions of the two discs.



PROCEDURA RAPIDA DI SMONTAGGIO SECONDO TALLONE - QUICK DEMOUNTING PROCEDURE FOR THE SECOND BEAD



Procedura rapida smontaggio secondo tallone resa possibile da **movimento disco brevettato**, particolarmente indicata per pneumatici a fianchi duri.

Quick demounting procedure for the second bead, thanks to the movement of our patented disc that's particularly suitable for tyres with hard walls.

3 MOTORIZZAZIONE CON SISTEMA MOTOINVERTER - MOTOINVERTER DRIVE SYSTEM



“ IN FASE DI ROTAZIONE
LA GIUSTA COPPIA PER OGNI VELOCITÀ.

DURING ROTATION
THE RIGHT TORQUE FOR EVERY SPEED

”



ARTIGLIO 5000

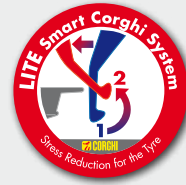

SCOPRI COME FUNZIONA
DISCOVER HOW IT WORKS



MOTOINVERTER:
La giusta coppia per ogni velocità
The right torque for every speed



4 SOLLEVATORE RUOTA - WHEEL LIFTER

Senza fatica - Il sollevatore consente di posizionare sull'autocentrante ogni tipo di ruota senza sforzo. Accessorio a richiesta. (85 kg)

No effort - The lifter positions any type of tyre on the turntable without effort. Optional accessory supplied on request. (85kg)



5 GRUPPO TESTATA - HEAD UNIT

NESSUN CONTATTO CON IL CERCHIO, RIDUZIONE DELLA TENSIONE DELLO PNEUMATICO
NO CONTACT WITH THE RIM. REDUCED STRESS ON THE TYRE

Gruppo testata di smontaggio e montaggio con innovativa soluzione **CONTACTLESS (Patent Pending)**.

La nuova **testata a posizionamento automatico** di nuovissima e brevettata concezione consente di smontare e montare lo pneumatico in modo molto semplice senza andare **mai a contatto con il cerchio** (CONTACTLESS) e di ridurre le tensioni dello pneumatico nelle fasi più impegnative. Dispositivo di **stallonatura dinamica** con doppio e speculare disco di stallonatura, bloccaggio ruota rapido, **grande ergonomia** di lavoro e consolle di comando consentono un **utilizzo efficiente**, facile e veloce di questa innovativa nuova macchina.

*Mounting and demounting head unit with the innovative **CONTACTLESS** solution (Patent Pending).*

*The newly designed and patented **automatically positioned head** allows the tyre to be mounted and demounted in a very simple way, **without ever touching the rim** (CONTACTLESS), and reduces the stress on the tyre during the most critical phases.*

***Dynamic bead breaking device** with double and specular bead breaker disc, quick wheel clamping, optimum ergonomics of the work procedure and control panel for the **efficient, quick and easy use** of this innovative new machine.*



6

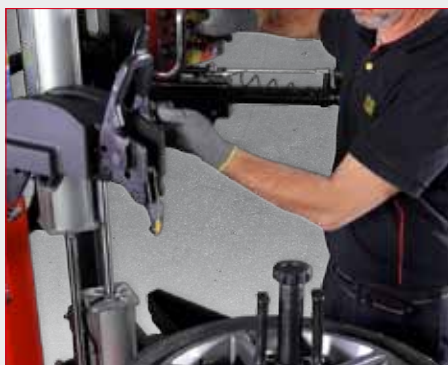

UTENSILE DI MONTAGGIO BASCULANTE - TILTING MOUNTING TOOL

L'utensile di smontaggio basculante, grazie ad un apposito comando, consente un **rapido ed efficace posizionamento della testata**. Questo apporta grande velocità ed efficienza di prestazioni. *Thanks to a specific command, the tilting demounting tool ensures the **quick, effective positioning of the head**. This means great speed and efficient performance.*



7 UNGHIA DI EMERGENZA - EMERGENCY HOOK

La rotazione dell'utensile agevola l'inserimento del tallone sul cerchio (per pneumatici extra soft)

The rotation of the tool makes it easier to install the bead on the rim (for extra-soft tyres)



8

PREMITALLONE (DI SERIE) BEAD DEPRESSOR (STANDARD)

- Premitalлоне ad altezza di lavoro regolabile
- La forma del pressore è ideale per pneumatici RFT ed anche utilizzabile per tenere sollevato il pneumatico
- *Bead depressor with adjustable working height*
- *The depressor shape is ideal for RFT tyres and can also be used to hold the tyre up*



“ RUN FLAT - NO PROBLEM! ”

ERGONOMIA - ERGONOMICS

Altezza di lavoro della macchina studiata per ottenere una **perfetta ergonomia nei movimenti** con tutti i tipi di ruote: Ideale per tutti gli operatori.
*Machine working height designed to obtain **perfect ergonomic movement** with all wheel types: Ideal for all operators.*



Tutti i comandi che controllano i movimenti della macchina si trovano in posizioni ergonomiche all'operatore

All machine movement controls are conveniently to hand for the operator



*eccezione per cerchi a canale rovescio.
**except for reverse rims.*

DATI TECNICI - TECHNICAL DATA

range dimensioni ruota	wheel dimension range	
diametro cerchio	rim diameter	da 13" a 28" - from 13" to 28"
diametro max pneumatico	maximum tyre diameter	1200 mm (47") - 1200 mm (47")
larghezza massima pneumatico	maximum tyre width	15" (dal piano appoggio ruota) - (from wheel supporting base)
pneumatici trattabili	tyre types processed	convenzionali, low profile e Run Flat - conventional, Low Profile and Run Flat
autocentrante	turntable	
bloccaggio	clamping	meccanico-manuale - mechanical-manual
motorizzazione	drive system	motoinverter 2 velocità - 2-speed motoinverter
coppia di rotazione	rotation torque	1100 Nm
velocità di rotazione	rotation speed	7-18 rpm
stallonatore	bead breaker	
campo massimo di stallonatura	maximum bead breaking range	670 mm
corsa stallonatore	bead breaker stroke	540 mm
forza stallonatore	bead breaker force	7600 N
carico/scarico ruota	wheel loading/unloading	
azionamento	operation	pneumatico - pneumatic
peso max ruota	max wheel weight	85 Kg
alimentazione	power supply	
elettrica 1Ph	electric 1Ph	230V-0,98 kW 50Hz/60 Hz
elettrica 1Ph (alternativa)	electric 1Ph (alternative)	110V-0,98 kW 50Hz/60 Hz
pneumatica di esercizio	pneumatic operating pressure	8 bar (minima) - 8 bar (minimum)
peso	weight	425 kg (con premitallone e sollevatore) 425 kg (with bead depressor and wheel lifter)

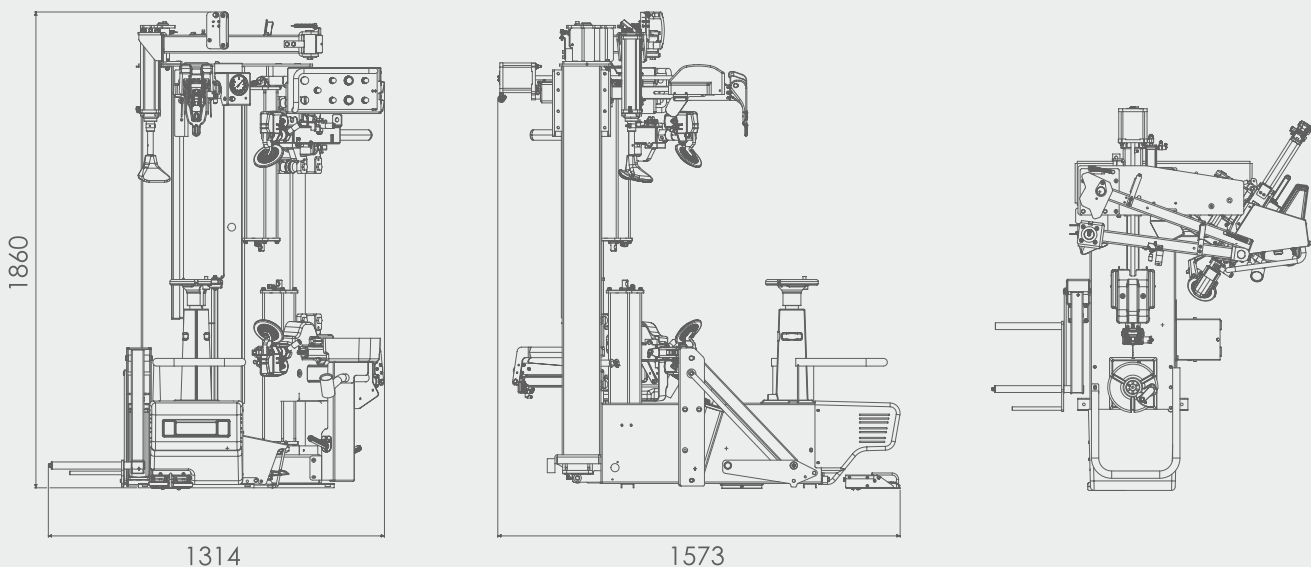
DIMENSIONI DI INGOMBRO - OVERALL DIMENSIONS

ACCESSORI IN DOTAZIONE - STANDARD ACCESSORIES



ACCESSORI CONSIGLIATI - RECOMMENDED ACCESSORIES

- A1** 8-11120053
Kit TI - Sistema gonfiaggio rapido
TI system Kit
- A2** 8-11120054
Kit TI - Sistema gonfiaggio rapido
ASME per USA e CANADA
*TI kit - ASME quick inflation system
for the USA and CANADA*
- B** 8-11100039
Flangia universale per cerchi
a canale rovescio
Reverse wheel flange
- C** 8-11100086
Kit cerchi furgone
Van rim kit
- D** 8-11100087
Flangia universale per cerchi ciechi e speciali
(per versione con bloccaggio manuale)
*Universal flange for reverse rims
(for version with manual clamping)*
- E** 8-11100237
Maniglia di bloccaggio AUTOLOCK II
AUTOLOCK II automatic clamping
- F** 8-11120052
Kit sollevatore ruota
Wheel lifter kit
- G** 0-51100502
TPM-02 Dispositivo portatile
per il controllo dei sensori TPMS
*TPM-02 Device for checking operation
of TPMS sensors*
- H** 8-11100120
Morsetto basculante
Sliding bead pressing clamp

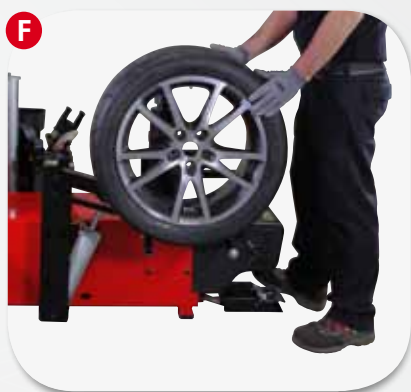
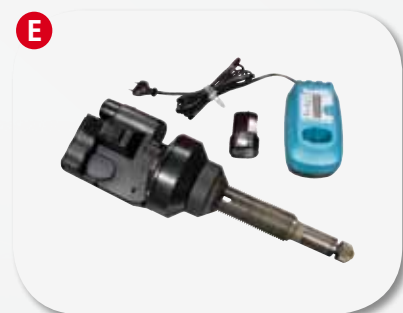
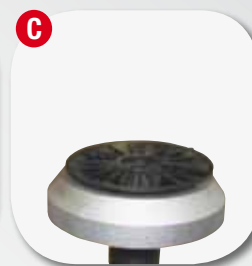

Per maggiori informazioni consultare il catalogo accessori completo
For further information, consult the complete accessories catalogue

Watch the Video ▶

